

1. CG201S1, One Gang Switch
2. CG201S2, Two Gang Switch
3. CG201DM, One Gang Dimmer

Wiring Diagram

Notes: The Neutral wire of load is closely connected to the Neutral point of CG201.

Situation 1: Live , Neutral and Load wires are ready at wallbox

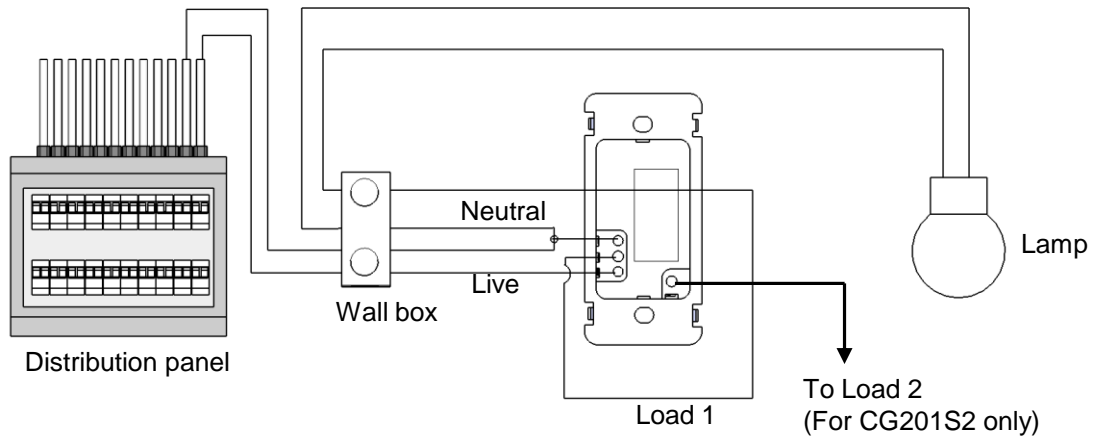

Situation 2: Live and Load wires are ready at wall box, Neutral wire is only ready at ceiling

