

CG130 SERIES

ZIGBEE WIRELESS SWITCH

USER MANUAL



CG130 Series

VERSION 0.0

1ST APRIL, 2015



Disclaimers and Copyright

Nothing contained in this publication is to be construed as granting any right, by implication or otherwise, for the manufacture, sale, or use in connection with any method, apparatus, or product covered by letters patent, or as insuring anyone against liability for infringement of letters patent.

Efforts have been made to ensure the accuracy and reliability of the data contained in this publication; however, Citygrow Energy Systems Limited. makes no representation, warranty, or guarantee in connection with this publication and hereby expressly disclaims any liability or responsibility for loss or damage resulting from its use or from the use of any product or methodology described herein; for any violation of any federal, state, or municipal regulation with which this publication may conflict; or for the infringement of any patent from the use of this publication. Nothing contained in this publication should be viewed as an endorsement by Citygrow Energy Systems Limited. of any particular manufacturer's products.

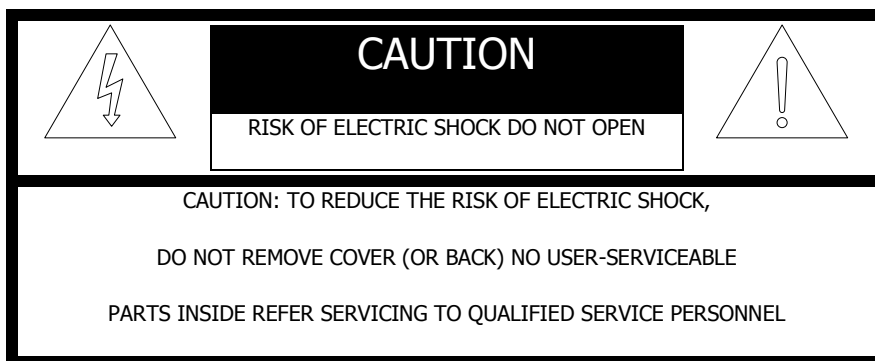

The lightning flash with arrowhead symbol within an equilateral triangle is intended to alert the user to the presence of uninsulated "dangerous voltage" within the product's enclosure that may be of sufficient magnitude to constitute a risk of electric shock to persons.

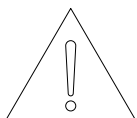

The exclamation point within an equilateral triangle is intended to alert the user to the presence of important operating and maintenance (servicing) instructions in the literature accompanying the product.

IMPORTANT SAFETY INSTRUCTIONS

READ BEFORE OPERATING EQUIPMENT

This product was designed and manufactured to meet strict quality and safety standards.

There are, however, some installation and operation precautions which you should be particularly aware of.

1. Read these instructions.
2. Keep these instructions.
3. Heed all warnings.
4. Follow all instructions.
5. Do not use this apparatus near water.
6. Clean only with dry cloth.
7. Do not block any ventilation openings. Install in accordance with the manufacturer's instructions.
8. Do not install near any heat sources such as radiators, heat registers, stoves, or other apparatus that produce heat.
9. Do not defeat the safety purpose of the polarized or grounding-type plug. If the provided plug does not fit into your outlet, consult an electrician for replacement of the outlet.
10. Protect the power cord from being walked on or pinched particularly at plugs, convenience receptacles, and the point where they exit from the apparatus.
11. Only use attachments/accessories specified by the manufacturer.
12. Use only with the cart, stand, tripod, bracket, or table specified by the manufacturer, or sold with the apparatus. When a cart is used, use caution when moving the cart/apparatus combination to avoid injury from tip-over.
13. Unplug this apparatus during lightning storms.
14. Refer all servicing to qualified service personnel. Servicing is required when the apparatus has been damaged in any way, such as power-supply cord or plug is damaged, liquid has been spilled or objects have fallen into the apparatus, the apparatus has been exposed to rain or moisture, does not operate normally, or has been dropped.

Table of content

1.	Introduction	1
2.	Understanding of the product	2
3.	Dimensions	3
4.	Wiring-CG130S1xx, CG130S2xx, CG130S4xx, CG130DMxx, CG130DM2xx	3
5.	Wiring-CG130S2xx-CCP, CG130S4xx-CCP.....	5
6.	Installation.....	6
7.	Operation instruction	8
7.1.	CG130S1xx, CG130S2xx, CG130S4xx.....	8
7.2.	CG130DMxx, CG130DM2xx	9
7.3.	CG130S2xx-CCP, CG130S4xx-CCP	10
7.3.1.	Operation	10
7.3.2.	Setting the open and close travel distant for the curtain.	12
8.	Adding the product to your Home Wireless ZigBee Network	14
9.	Specification.....	15

1. Introduction

Thank you for buying Citygrow's product. CG130 Series is both powerful and easy to use and install. It is specially designed for wireless remote control Home Automation purpose.

Description

1. ZigBee wireless remote control.
2. Based on IEEE 802.15.4.
3. 2.4GHz radio frequency.
4. CG130S1, S2, S4, DM, DM2 is for lighting control
5. CG130xxH2 is for 4 scenes control
6. CG130S2-CCP, CG130S4-CCP is for control of electronic curtain or window blind.
7. LED indicator for on/off status.
8. Load/ loads are directly driven by the build-in driver.
9. Control button can be configured to become two way function.
10. Control button can be configured to become scene function.
11. Support iPhone, iPad and Android mobile control if CG102BS Base station is purchased.
12. Control button graphics can be tailor-made per customer requirement.
13. Mounted in a standard UK wall box.
14. No EIB / Bus required
15. Easy to install.

2. Understanding of the product

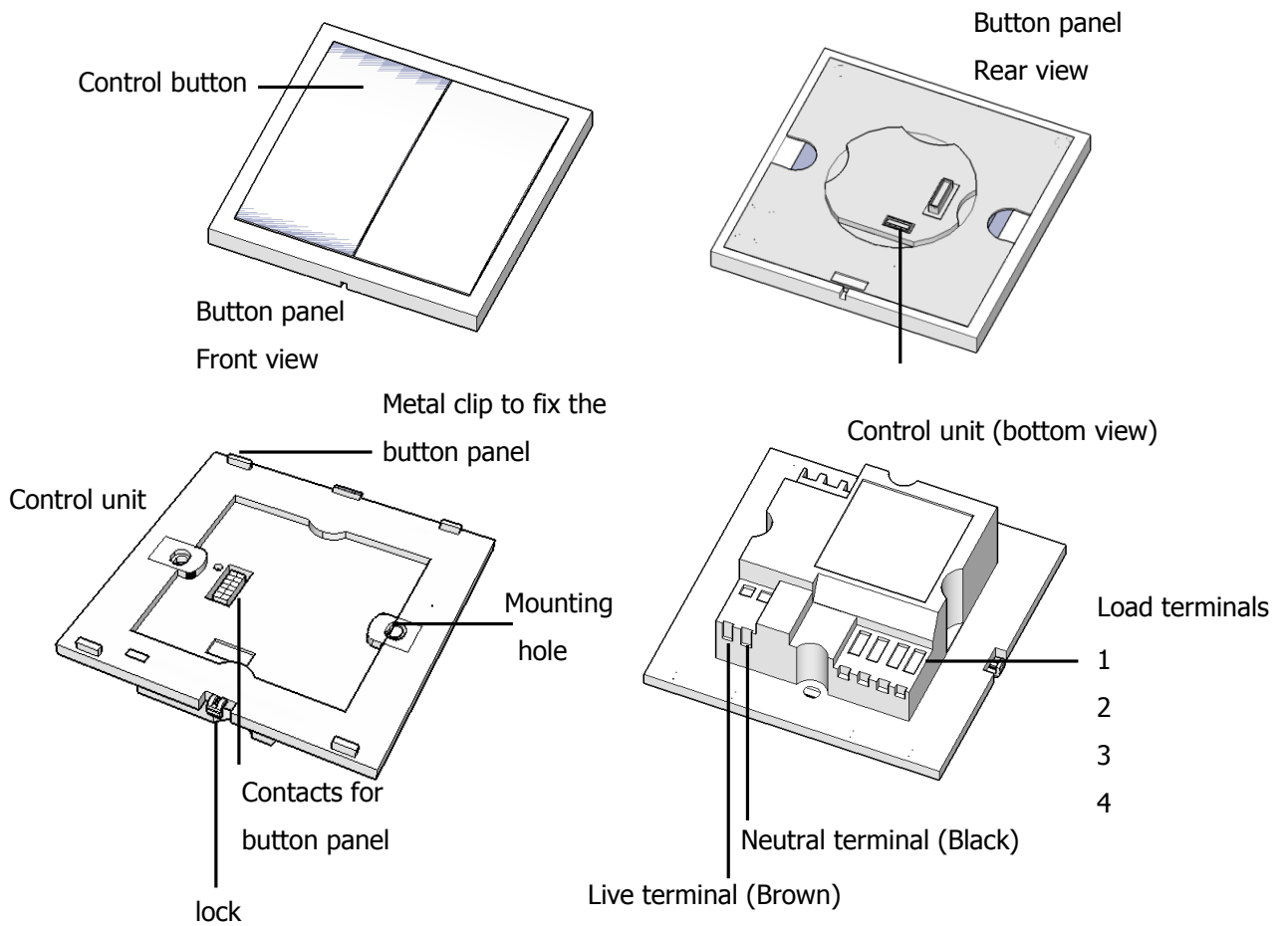

Load terminals	1	2	3	4
CG130S1 One Gang Switch	Load1	NC	NC	NC
CG130S2 Two Gang Switch	Load2	Load1	NC	NC
CG130S4 Four Gang Switch	Load4	Load3	Load 2	Load 1
CG130DM One Gang Dimmer	Load1	NC	NC	NC
CG130DM2 Two Gang Dimmer	Load2	Load1	NC	NC
CG130S2-CCP One Gang Curtain Control Switch	Motor 1 Backward	Motor 1 Forward	NC	NC
CG130S4-CCP Two Gang Curtain Control Switch	Motor 2 Backward	Motor 2 Forward	Motor 1 Backward	Motor 1 Forward

3. Dimensions

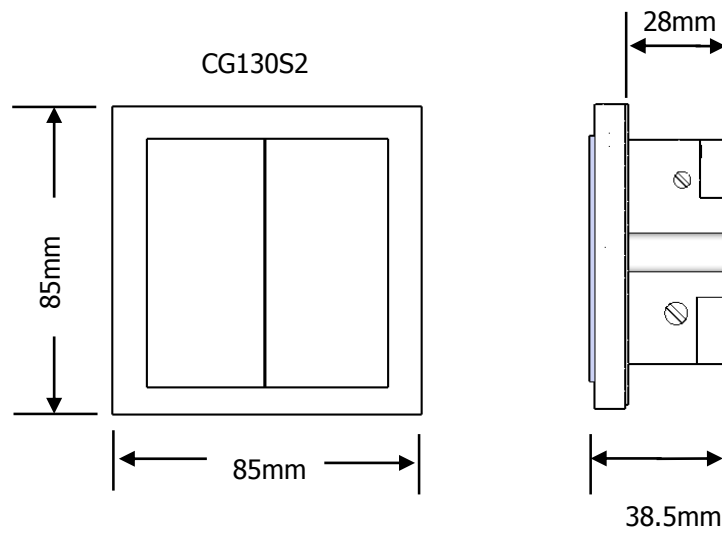

4. Wiring-CG130S1xx,CG130S2xx, CG130S4xx, CG130DMxx, CG130DM2xx

Notes:The Neutral wire of load is closely connected to the Neutral point of CG130.

Situation 1: Live, Neutral and Load wires are ready at wall box

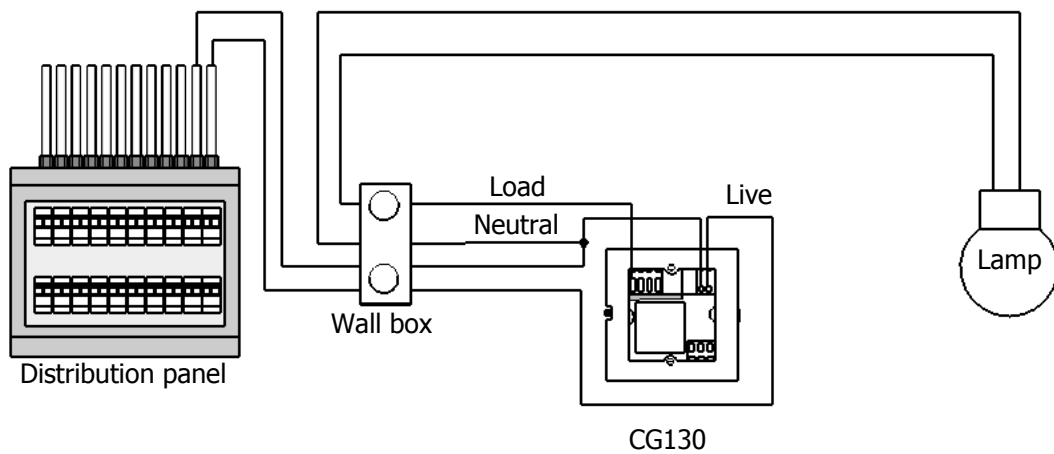

Situation 2: Live and Load wires are ready at wall box, Neutral wire is only ready at ceiling

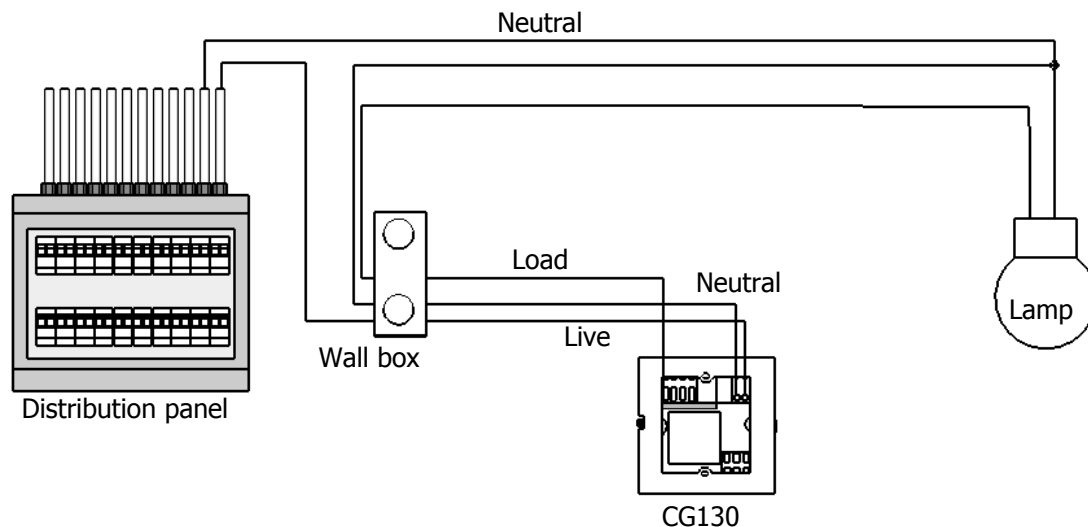

Before getting started



WARNING! It must be installed by a qualified electrician in accordance with all applicable regulations and building codes. Improper wiring can result in personal injury or damage to control units or other equipment. Always turn off circuit breaker or remove main fuse from power line before doing any work. To avoid overheating and possible damage to equipment.



WARNING! Do not operate when any lamps removed or burned out; replace any burned out lamps immediately; use only transformers that incorporate thermal protection or fused primary windings. ! This product is designed for residential and commercial use, for indoor use only.



WARNING! Install in accordance with all national and local electrical codes.



IMPORTANT! Citygrow® is not liable for any damage incurred with the misuse of this product.



IMPORTANT! Pre-setup can only be done by a professional worker or manufacturer agent.

5. Wiring-CG130S2xx-CCP, CG130S4xx-CCP

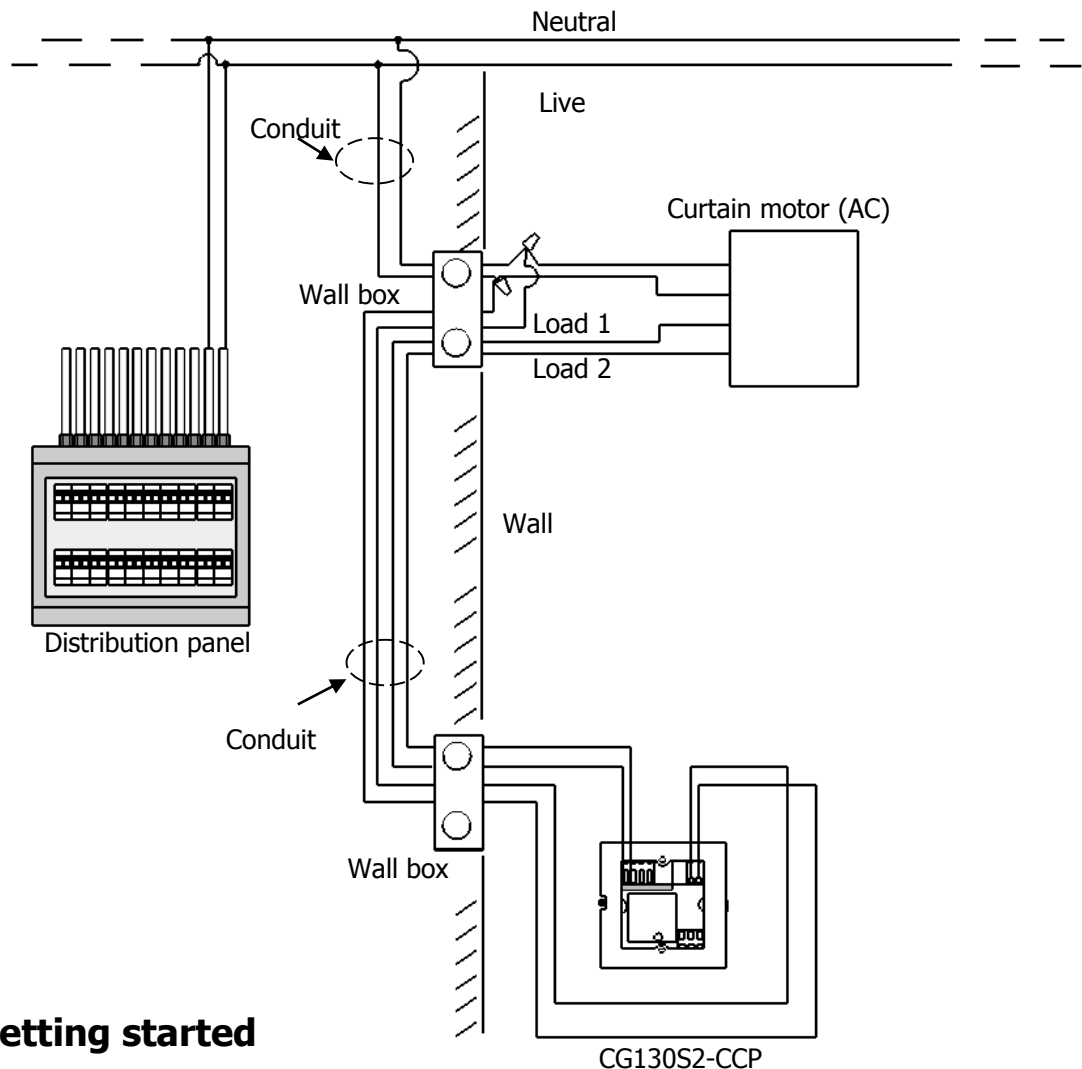

Before getting started



WARNING! It must be installed by a qualified electrician in accordance with all applicable regulations and building codes. Improper wiring can result in personal injury or damage to control units or other equipment. Always turn off circuit breaker or remove main fuse from power line before doing any work. To avoid overheating and possible damage to equipment.



WARNING! Do not operate when any lamps removed or burned out; replace any burned out lamps immediately; use only transformers that incorporate thermal protection or fused primary windings. ! This product is designed for residential and commercial use, for indoor use only.



WARNING! Install in accordance with all national and local electrical codes.



IMPORTANT! Citygrow® is not liable for any damage incurred with the misuse of this product.



IMPORTANT! Pre-setup can only be done by a professional worker or manufacturer agent.

6. Installation

In order to install the product correctly, please follow the below steps:

STEP 1: IMPORTANT! Turn off main power at the main switch board.

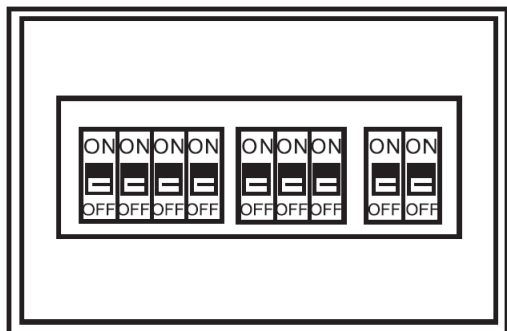

STEP 2: Loosen the screws of the original wall switch. Remove the switch and disassemble the wiring.

STEP 3: Connect the main power cable to the Live and Neutral terminals and the load cable to the Load terminals at the rear cabinet of the product.

STEP 4: Fasten the screws of all terminals and check that the wires are properly secured. Retrofit the switch into the standard switch box and mount it on the wall by fastening the two screws at the rear of the switch box.

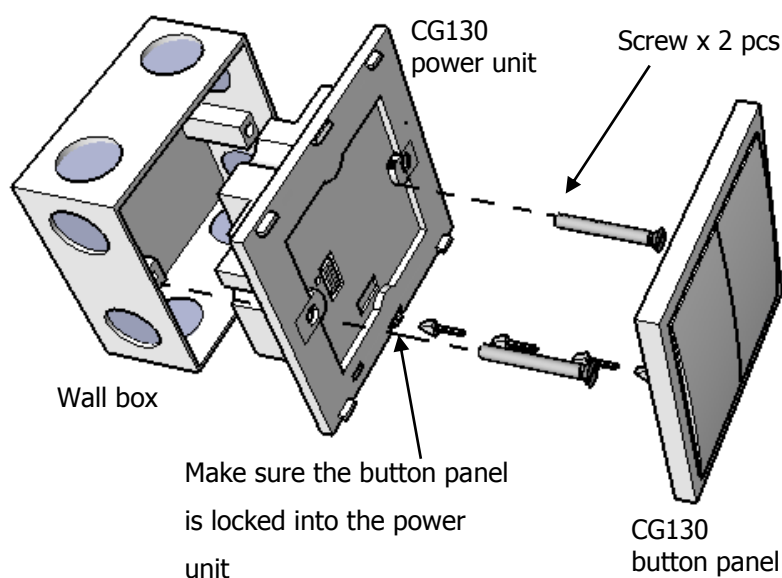

STEP 5: Push the ON/OFF button, to test whether the wiring has been connected correctly. If the ON/OFF Button does not function as expected, please check the wiring connection again.

Notes: Use standard UK wall box BS4662; minimum 35mm deep. During installation of the wall box, it is recommended to embed the wall box deeper inside the wall in order to give more room to install the product. The room inside is recommended to have 50mm deep.

7. Operation instruction

7.1. CG130S1xx, CG130S2xx, CG130S4xx

CONTROL PANEL

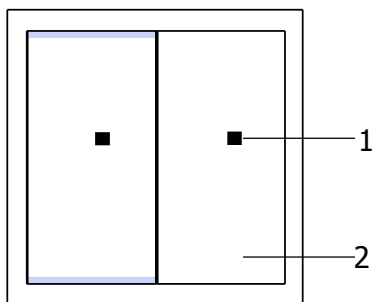

1. LED Indicator
2. ON/OFF Button
3. Program port
4. Metal clip
5. Mounting hole

POWER MODULE

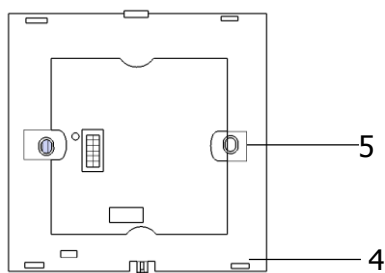

- Press ON/OFF Button once to toggle between ON and OFF.
 - **BRIGHT** LED indicates that the Switch is ON.
 - **DIMMED** LED indicates that the Switch is OFF.

7.2. CG130DMxx, CG130DM2xx

CONTROL PANEL

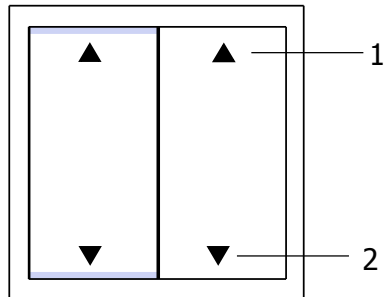

1. Dim Up/LED Indicator
2. Dim Down/LED Indicator
3. Program port
4. Metal clip
5. Mounting hole

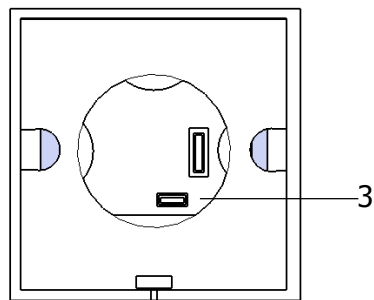

POWER MODULE

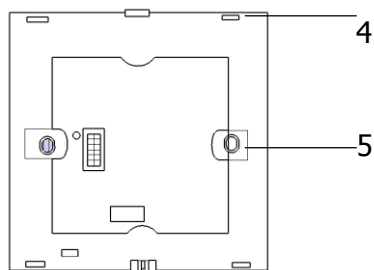

- Press the Dim Up/Dim Down button **ONCE** to Toggle between ON and OFF.
 - LED **FLASHING** indicates that that the Button was pressed and dimming is in progress.
 - When the LED stops flashing, it indicates that the dimming is complete.
- Press and **HOLD** the Dim Up/Dim Down button to begin dimming.
 - Release the button at desired level.

7.3. CG130S2xx-CCP, CG130S4xx-CCP

7.3.1. Operation

CONTROL PANEL

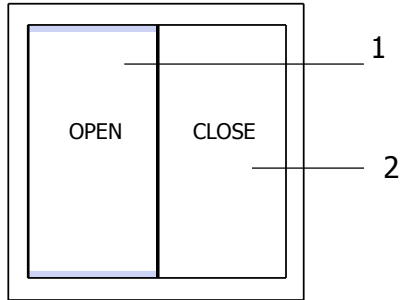

- 1. Open button
- 2. Close button
- 3. Program port
- 4. Metal clip
- 5. Mounting hole

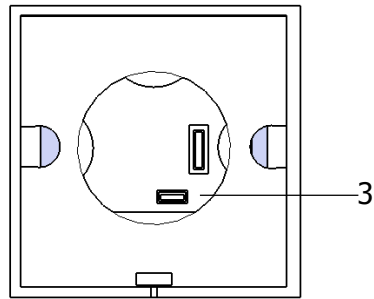

POWER MODULE

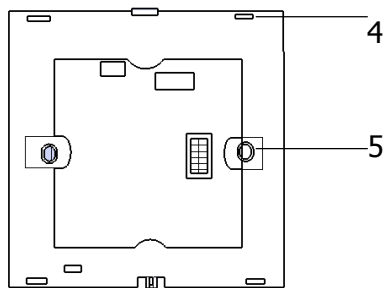

- Press the Open/Close Button once to control the electric curtain.
 - When the electric curtain is stopped, press the **OPEN** button to open the electric curtain.
 - When the electric curtain is stopped, press the **CLOSE** button to close the electric curtain.
 - When the electric curtain is running, press **ANY** button to stop the electric curtain.

7.3.2. Setting the open and close travel distant for the curtain.

The function of the Learning Mode in the CG130S2-CCP is to program the duration of the curtain Opening/Closing time.

In order to perform the Learning Mode function, please follow the below steps:

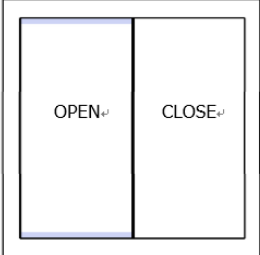
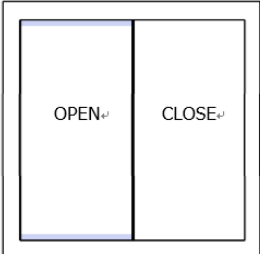
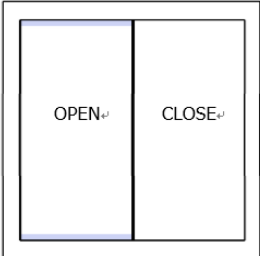
	<p>STEP 1</p> <ul style="list-style-type: none"> - Press the CLOSE Button until the curtain is fully closed. <p>NOTE: You may have to press the Button once or more times in order for the curtain to be fully closed.</p>
	<p>STEP 2</p> <ul style="list-style-type: none"> - Press and HOLD the Reset Button. - While still holding the Reset Button, press and HOLD the Open Button.
	<p>STEP 3</p> <ul style="list-style-type: none"> - Release the Reset Button. - Wait until the LED Indicators begins BLINKING. - Release the Open Button.

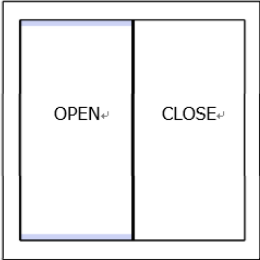
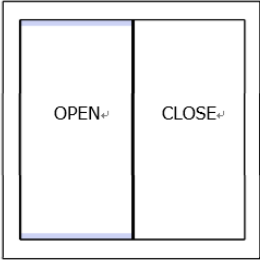
	<p>NOTE: The curtain should be opening at this point.</p>
	<p>STEP 4</p> <ul style="list-style-type: none"> - Once the curtain is fully opened, press and release any Button. <p>NOTE: The duration of the Opening/Closing time will be stored once the Button is pressed.</p>
	<p>STEP 5</p> <ul style="list-style-type: none"> - Use a thin object to press the Reset Button again. - The learning process of the CG130S2-CCP has now finished.

Do the same for CG130S4-CCP, the only difference is CG130S4-CCP will control 2 curtains. CG130S2-CCP can only control 1 curtain. So, for CG130S4-CCP will need to program both curtain travelling time.

8. Adding the product to your Home Wireless

ZigBee Network

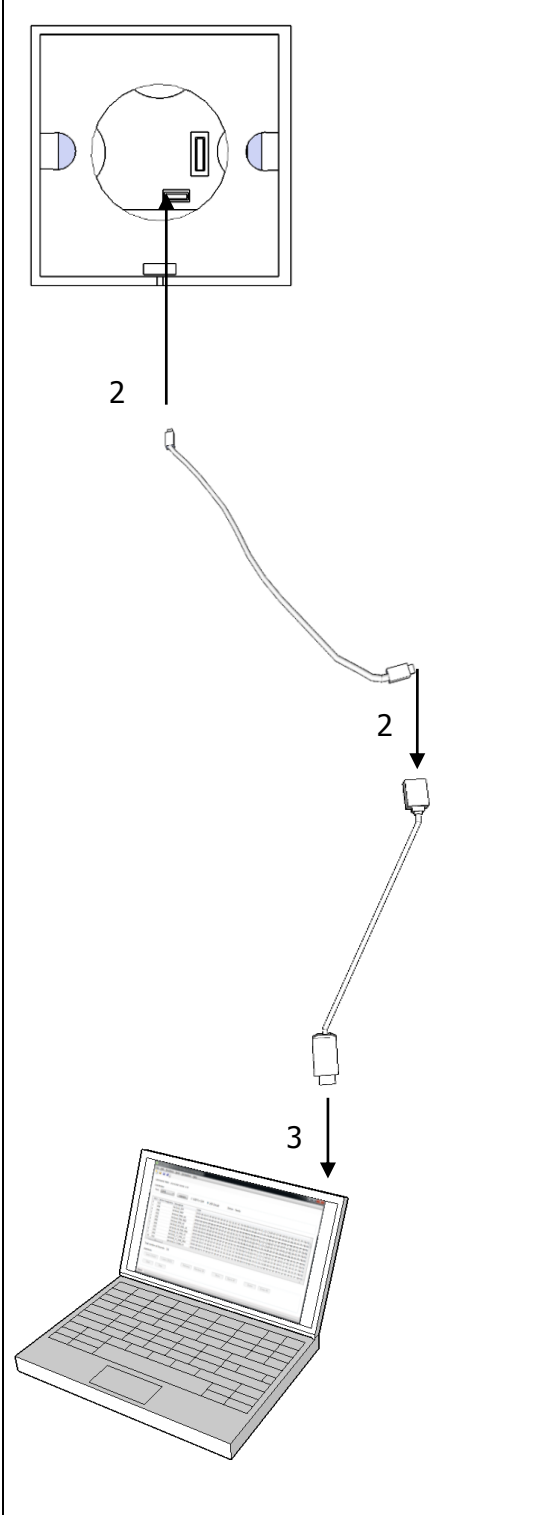
 <p>The diagram illustrates the connection process in three steps:</p> <ol style="list-style-type: none"> STEP 1: A cable is shown being inserted into a 5-pin connector on the back of a device. STEP 2: The other end of the cable is shown being inserted into a mini USB port. STEP 3: The mini USB port is shown being inserted into the USB port of a PC, which is connected to a laptop. 	<p>STEP 1</p> <p>Open the front cover, you will see a 5 pin connector.</p> <p>STEP 2</p> <p>Plug the CG101UT5 cable into the 5 pin connector of the product, and then plug the other end of the CG101UT5 cable into the mini USB end of the CG101UTC cable.</p> <p>STEP 3</p> <p>Plug the CG101UTC cable into the USB port of a PC that is installed with Citygrow's HomeNET Planner Software.</p> <p>STEP 4</p> <p>Refer to the user manual of "HomeNET Planner" Software to program and set the address of the product.</p>
---	---

9. Specification

	CG130S1	CG130S2	CG130S4	CG130DM	CG130DM2	CG130S2- CCP	CG130S4 _CCP
Description	One Gang Switch	Two Gang Switch	Four Gang Switch	One Gang Dimmer (Leading Edge Dimming)	Two Gang Dimmer (Leading Edge Dimming)	One Gang Curtain Control Switch	Two Gang Curtain Control Switch
Operating voltage	AC220-240V, 50Hz						
Maximum number of devices included in scene setting** (Remarks 1, 2)	50	50	50	50	50	NO	NO
**Remarks: 1. When up button is used for dimming up function, the down button cannot be programmed as scene function 2. Maximum number of devices programmed into the whole product is limited to 50 devices 3. The maximum load requirements for fluorescent, CFL and LED loads can vary greatly depending upon the specific fixture and /or bulb being used. 4. When dimming transformer is connected to CG130, make sure "dimnable" and "leading edge" type is used. Furthermore, the dimming performance varies greatly from manufacturer to manufacturer of the bulb and the dimming transformer. It is recommended to test the matching performance before mass deployment.							
Minimum dimming level setting	NO	NO	NO	YES	YES	NO	NO
Memory dim function	NO	NO	NO	YES	YES	NO	NO
Two way control function	YES	YES	YES	YES	YES	YES	YES
RF frequency	2.4GHZ	2.4GHZ	2.4GHZ	2.4GHZ	2.4GHZ	2.4GHZ	2.4GHZ
Remote control distance (M, line of sight)	100M	100M	100M	100M	100M	100M	100M
Dimensions mm (Length x Width x Depth)	87x87x39	87x87x39	87x87x39	87x87x39	87x87x39	87x87x39	87x87x39
Recommended operation temperature	0 to 40 degC	0 to 40 degC	0 to 40 degC	0 to 40 degC	0 to 40 degC	0 to 40 degC	0 to 40 degC

	CG130S1	CG130S2	CG130S4	CG130DM	CG130DM2	CG130S2-CCP	CG130S4-CCP
Description	One Gang Switch	Two Gang Switch	Four Gang Switch	One Gang Dimmer (Leading Edge Dimming)	Two Gang Dimmer (Leading Edge Dimming)	One Gang Curtain Control Switch	Two Gang Curtain Control Switch
Resistive load 1. Incandescent 2. Halogen 3. Electronic low voltage – ELV transformer	2000W	1000W / gang	500W / gang	600W	300W/ gang		
Inductive load 1. Magnetic low voltage – MLV transformer. 2. Iron core / Inductive transformer	2000VA	1000VA/ gang	500VA/ gang	600VA	300VA/ gang		
Fluorescent	1400W	700W / gang	350W / gang				
Compact fluorescent - CFL	400W Max. 24 pcs CFL**	400W / gang Max. 24 pcs CFL/Gang**	200W / gang Max. 12 pcs CFL/Gang* *	400W Dimmable CFL Max. 20 pcs CFL**	200W/ gang Dimmable CFL Max. 20 pcs CFL/Gang**		
LED – GU10	200W	200W / gang	100W / gang	60W	30W / gang		
LED – MR16, MR11 With electronic low voltage LED driver	400W Max. 24 pcs ELV LED driver**	400W / gang Max. 24 pcs ELV LED driver /Gang **	200W / gang Max 12 pcs ELV LED driver / Gang**	120W Max. 15 pcs ELV LED driver**	60W / gang Max. 15 pcs ELV LED driver/Gang**		
LED strip With electronic low voltage driver	400W Max. 10 pcs ELV LED driver**	400W / gang Max. 10 pcs ELV LED driver /Gang **	200W / gang Max 5 pcs ELV LED driver / Gang**				
Exhaust fan	300VA	300VA / gang	200VA / gang				
3 wire type AC curtain motor						300VA	300VA / gang
Minimum load				5W	5W / gang		

TECHNICAL INFORMATION AND PICTURES SUBJECTED TO CHANGE WITHOUT PRIOR NOTICE
Copyright © 2012 Citygrow Energy Systems Ltd., All Rights Reserved