

CG300 SERIES

ZIGBEE WIRELESS SWITCH

USER MANUAL



CG300S1
One Gang Switch



CG300S2
Two Gang Switch



CG300DM
One Gang Dimmer

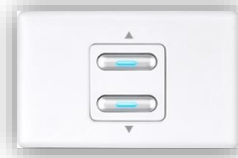

CG300S2-CCP
One Gang Curtain
Control Switch

VERSION 1.1

17 JANUARY, 2014



Disclaimers and Copyright

Nothing contained in this publication is to be construed as granting any right, by implication or otherwise, for the manufacture, sale, or use in connection with any method, apparatus, or product covered by letters patent, or as insuring anyone against liability for infringement of letters patent.

Efforts have been made to ensure the accuracy and reliability of the data contained in this publication; however, Citygrow Energy Systems Limited. makes no representation, warranty, or guarantee in connection with this publication and hereby expressly disclaims any liability or responsibility for loss or damage resulting from its use or from the use of any product or methodology described herein; for any violation of any federal, state, or municipal regulation with which this publication may conflict; or for the infringement of any patent from the use of this publication. Nothing contained in this publication should be viewed as an endorsement by Citygrow Energy Systems Limited. of any particular manufacturer's products.

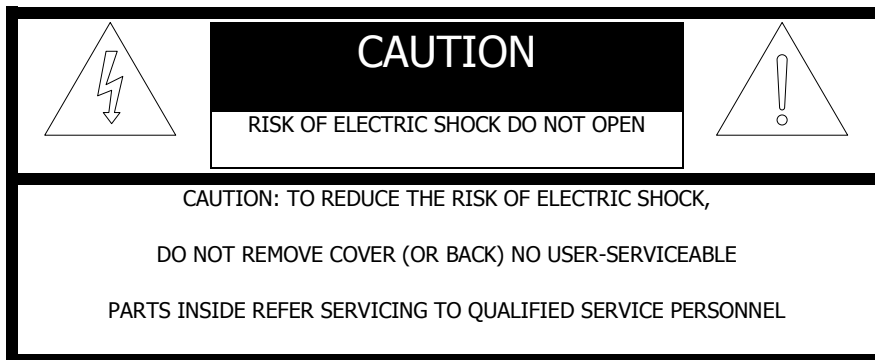

The lightning flash with arrowhead symbol within an equilateral triangle is intended to alert the user to the presence of uninsulated “dangerous voltage” within the product’s enclosure that may be of sufficient magnitude to constitute a risk of electric shock to persons.

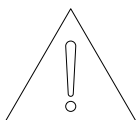

The exclamation point within an equilateral triangle is intended to alert the user to the presence of important operating and maintenance (servicing) instructions in the literature accompanying the product.

IMPORTANT SAFETY INSTRUCTIONS

READ BEFORE OPERATING EQUIPMENT

This product was designed and manufactured to meet strict quality and safety standards.

There are, however, some installation and operation precautions which you should be particularly aware of.

1. Read these instructions.
2. Keep these instructions.
3. Heed all warnings.
4. Follow all instructions.
5. Do not use this apparatus near water.
6. Clean only with dry cloth.
7. Do not block any ventilation openings. Install in accordance with the manufacturer’s instructions.
8. Do not install near any heat sources such as radiators, heat registers, stoves, or other apparatus that produce heat.
9. Do not defeat the safety purpose of the polarized or grounding-type plug. If the provided plug does not fit into your outlet, consult an electrician for replacement of the outlet.
10. Protect the power cord from being walked on or pinched particularly at plugs, convenience receptacles, and the point where they exit from the apparatus.
11. Only use attachments/accessories specified by the manufacturer.
12. Use only with the cart, stand, tripod, bracket, or table specified by the manufacturer, or sold with the apparatus. When a cart is used, use caution when moving the cart/apparatus combination to avoid injury from tip-over.
13. Unplug this apparatus during lightning storms.
14. Refer all servicing to qualified service personnel. Servicing is required when the apparatus has been damaged in any way, such as power-supply cord or plug is damaged, liquid has been spilled or objects have fallen into the apparatus, the apparatus has been exposed to rain or moisture, does not operate normally, or has been dropped.

Table of content

1. Introduction.....	1
2. Understanding of the product.....	2
3. Dimensions.....	3
4. Wiring-CG300S1, CG300S2, CG300DM	3
5. Wiring – CG300S2-CCP	5
6. Installation	6
7. Operation instruction	8
7.1. CG300S1.....	8
7.2. CG201S2.....	9
7.3. CG300DM.....	10
7.4. CG300S2-CCP.....	11
7.4.1. Setting the open and close travel distant for the curtain.	12
8. Adding the product to your Home Wireless ZigBee Network.....	14
9. Clear Memory	15
10. Specification	17

1. Introduction

Thank you for buying Citygrow's product. CG201 Series is both powerful and easy to use and install. These products are specially designed for Home Automation use.

Description

1. ZigBee wireless remote control.
2. Based on IEEE 802.15.4.
3. 2.4GHz radio frequency.
4. CG300S1, S2, DM is for lighting control.
5. CG300S2-CCP is for control of electronic curtain or window blind.
6. LED indicator for on/off status.
7. Load/ loads are directly driven by the build-in driver.
8. Control button can be configured to become two way function.
9. Control button can be configured to become scene function.
10. Support iPhone, iPad and Android mobile control if CG102BS Base station is purchased.
11. Control button graphics can be tailor-made per customer requirement.
12. Mounted in a standard US wall box.
13. No EIB / Bus required
14. Easy to install.

2. Understanding of the product

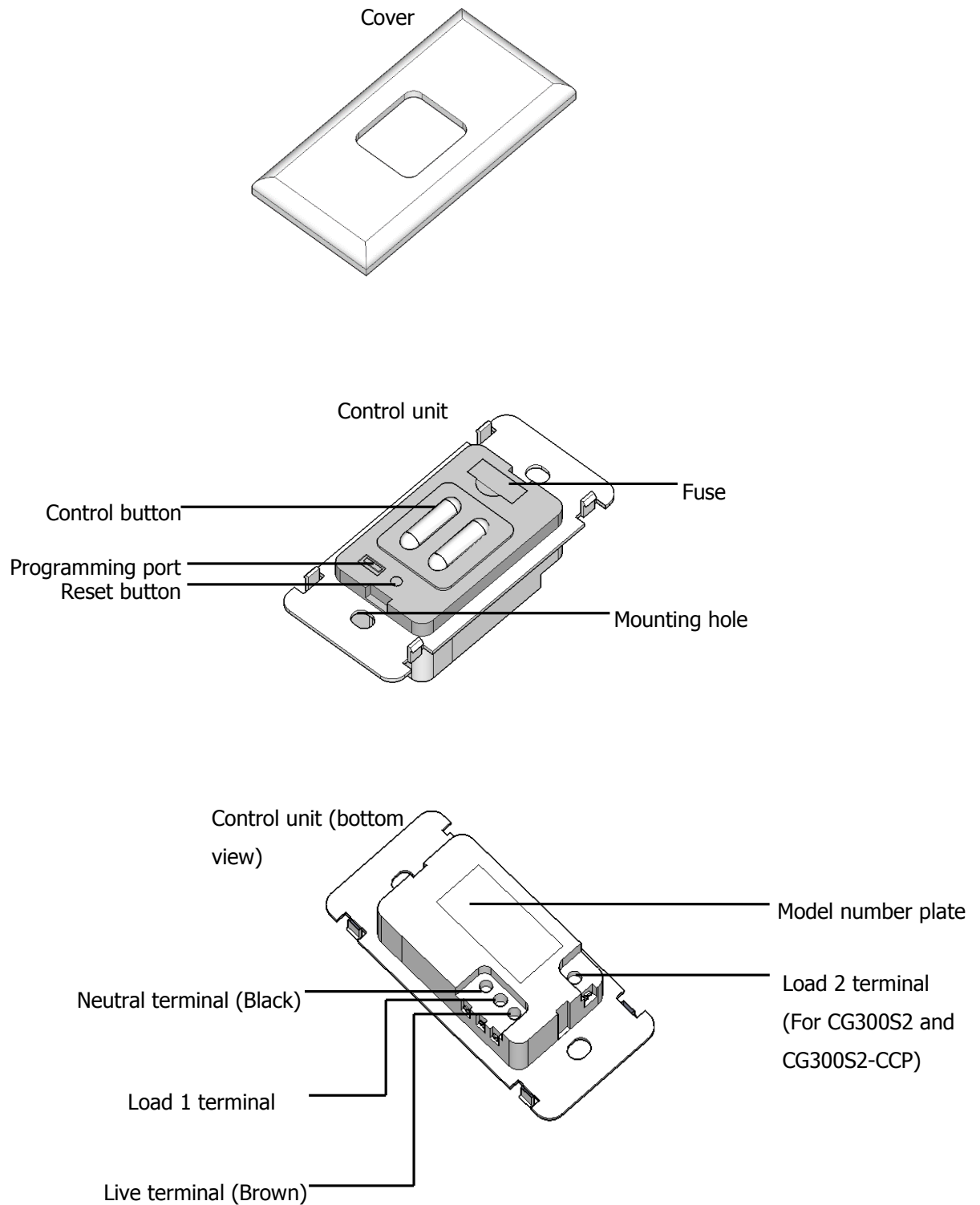

3. Dimensions

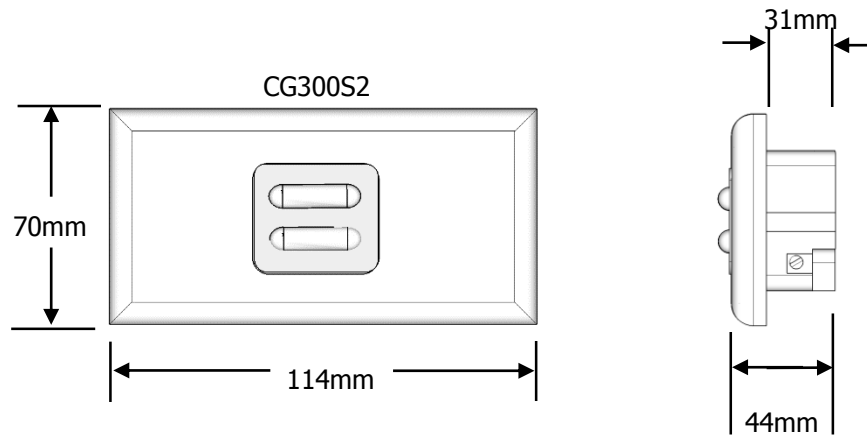

4. Wiring-CG300S1, CG300S2, CG300DM

Notes: The Neutral wire of load is closely connected to the Neutral point of CG300.

Situation 1: Live , Neutral and Load wires are ready at wall box

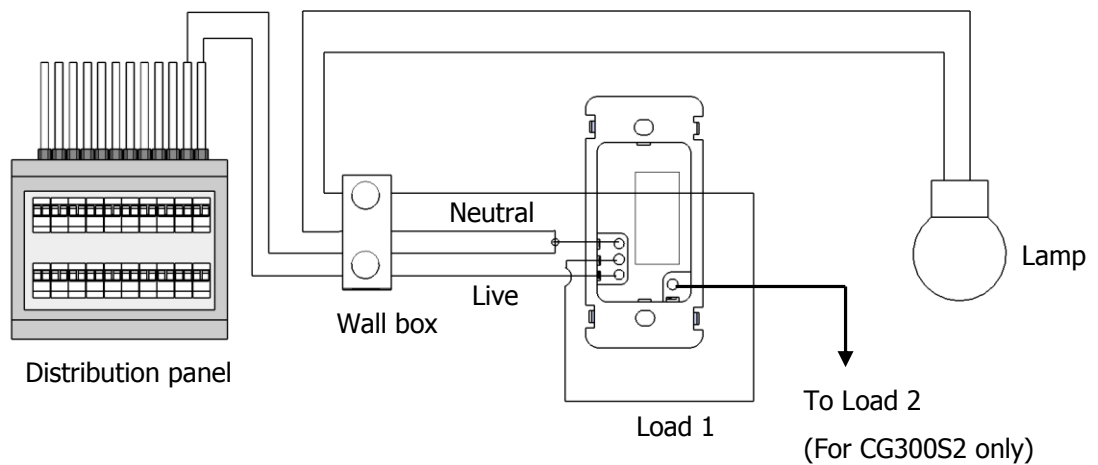

Situation 2: Live and Load wires are ready at wall box, Neutral wire is only ready at ceiling

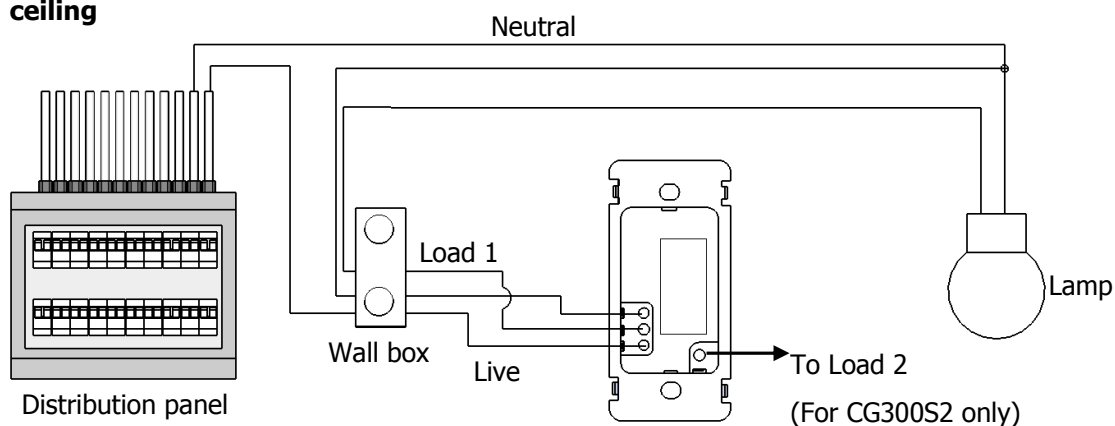

Before getting started



WARNING! It must be installed by a qualified electrician in accordance with all applicable regulations and building codes. Improper wiring can result in personal injury or damage to control units or other equipment. Always turn off circuit breaker or remove main fuse from power line before doing any work. To avoid overheating and possible damage to equipment.



WARNING! Do not operate when any lamps removed or burned out; replace any burned out lamps immediately; use only transformers that incorporate thermal protection or fused primary windings. ! This product is designed for residential and commercial use, for indoor use only.



WARNING! Install in accordance with all national and local electrical codes.



IMPORTANT! Citygrow® is not liable for any damage incurred with the misuse of this product.



IMPORTANT! Pre-setup can only be done by a professional worker or manufacturer agent.

5. Wiring – CG300S2-CCP

Notes: The Neutral wire of load is closely connected to the Neutral point of CG300.

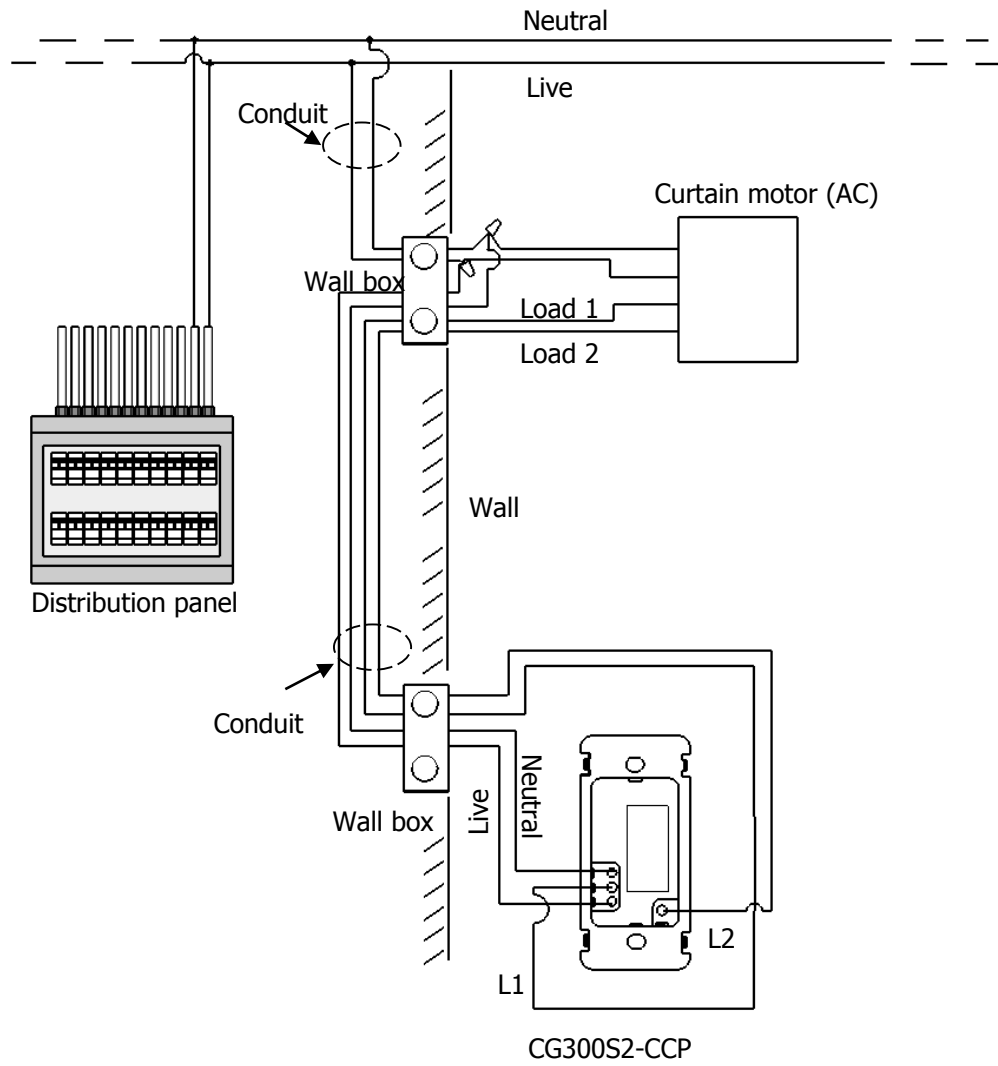

6. Installation

In order to install the product correctly, please follow the below steps:

STEP 1: IMPORTANT! Turn off main power at the main switch board.

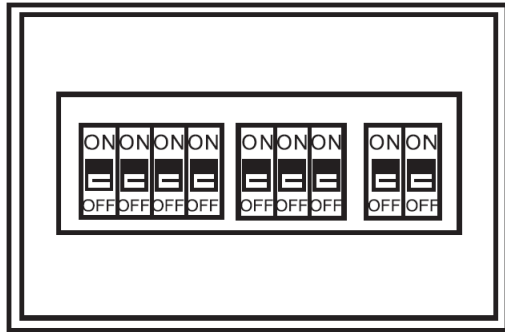

STEP 2: Loosen the screws of the original wall switch. Remove the switch and disassemble the wiring.

STEP 3: Connect the main power cable to the Live and Neutral terminals and the load cable to the Load terminals at the rear cabinet of the product.

STEP 4: Fasten the screws of all terminals and check that the wires are properly secured. Retrofit the switch into the standard switch box and mount it on the wall by fastening the two screws at the rear of the switch box.

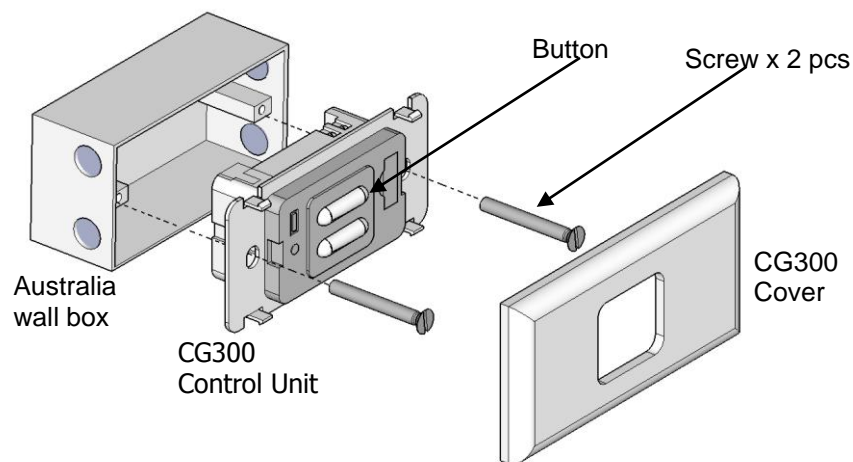

STEP 5: Push the control button to test whether the wiring has been connected correctly. If the control button does not function as expected, please check the wiring connection again.

Notes: Use standard Australia wall box; minimum 35mm deep. During installation of the wall box, it is recommended to embed the wall box deeper inside the wall in order to give more room to install the product. The room inside is recommended to have 50mm deep.

7. Operation instruction

7.1. CG300S1

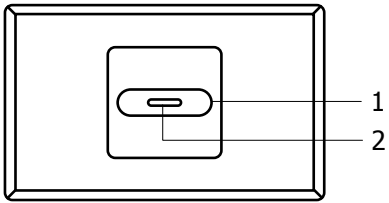
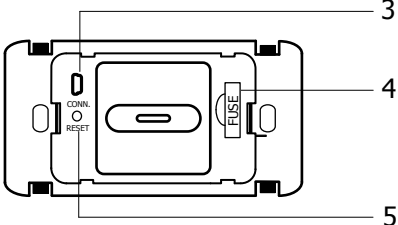
COVER PLATE	
	<ol style="list-style-type: none"> 1. ON/OFF Button 2. LED Indicator
MAIN UNIT	
	<ol style="list-style-type: none"> 3. Program port 4. Reset Button 5. Fuse

1. Press ON/OFF Button once to toggle between ON and OFF.
 - LED **ON** indicates the Switch is OFF.
 - LED **OFF** indicates the Switch is ON.

7.2. CG201S2

COVER PLATE

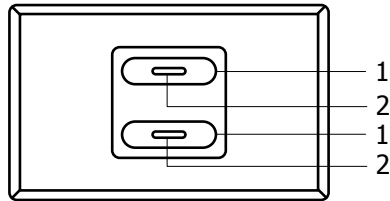

1. ON/OFF Button
2. LED Indicator

MAIN UNIT

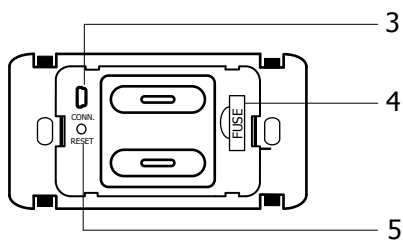

3. Program port
4. Reset Button
5. Fuse

1. Press ON/OFF Button once to toggle between ON and OFF.
 - LED **ON** indicates the Switch is OFF.
 - LED **OFF** indicates the Switch is ON.

- Release the button at desired level.

7.3. CG300DM

COVER PLATE

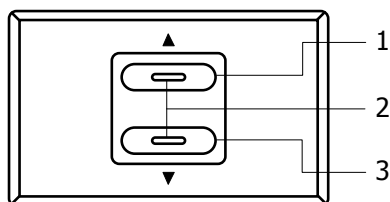

1. Dim Up/Toggle Button
2. LED Indicator
3. Dim Down/Toggle Button

MAIN UNIT

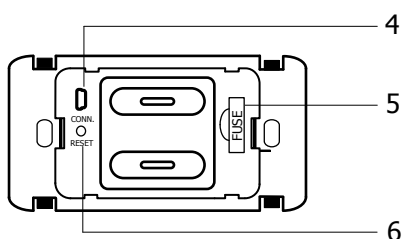

4. Program port
5. Reset Button
6. Fuse

1. Press the Dim Up/Dim Down button **ONCE** to Toggle between ON and OFF.
 - LED **FLASHING** indicates that that the Button was pressed and dimming is in progress.
 - When the LED stops flashing, it indicates that the dimming is complete.

2. Press and **HOLD** the Dim Up/Dim Down button to begin dimming.
 - Release the button at desired level.

7.4. CG300S2-CCP

COVER PLATE

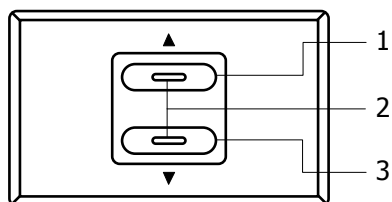

1. Open Button
2. LED Indicator
3. Close Button

MAIN UNIT

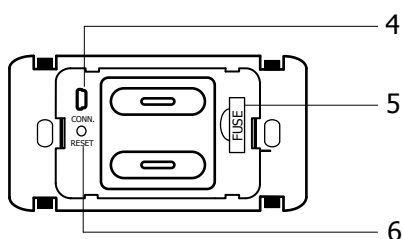

4. Connector
5. Reset Button
6. Fuse

1. Press the Open/Close Button once to control the electric curtain.
 - When the electric curtain is stopped, press the **OPEN** button to open the electric curtain.
 - When the electric curtain is stopped, press the **CLOSE** button to close the electric curtain.
 - When the electric curtain is running, press **ANY** button to stop the electric curtain.

7.4.1. Setting the open and close travel distant for the curtain.

The function of the Learning Mode in the CG300S2-CCP is to program the duration of the curtain Opening/Closing time.

In order to perform the Learning Mode function, please follow the below steps:

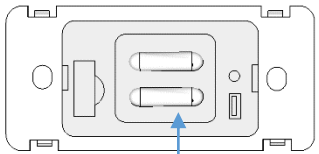
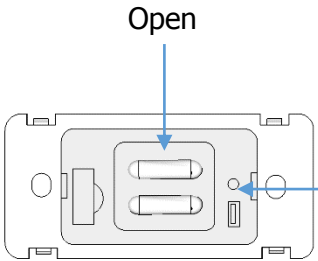
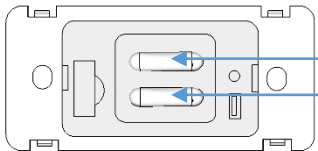
 <p style="text-align: center;">Close</p>	<p>STEP 1</p> <ul style="list-style-type: none"> - Press the CLOSE Button until the curtain is fully closed. <p>NOTE: You may have to press the Button once or more times in order for the curtain to be fully closed.</p>
 <p style="text-align: center;">Open</p> <p style="text-align: right;">Reset</p>	<p>STEP 2</p> <ul style="list-style-type: none"> - Press and HOLD the Reset Button. - While still holding the Reset Button, press and HOLD the Open Button.
 <p style="text-align: right;">Open</p> <p style="text-align: right;">Reset</p>	<p>STEP 3</p> <ul style="list-style-type: none"> - Release the Reset Button. - Wait until the LED Indicators begins BLINKING. - Release the Open Button.

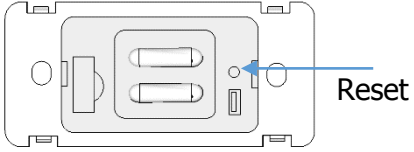
	<p>NOTE: The curtain should be opening at this point.</p>
	<p>STEP 4</p> <ul style="list-style-type: none"> - Once the curtain is fully opened, press and release any Button. <p>NOTE: The duration of the Opening/Closing time will be stored once the Button is pressed.</p>
 <p>The diagram shows the internal components of the CG300S2-CCP control panel. A blue arrow points to a small circular button on the right side of the panel, which is labeled "Reset".</p>	<p>STEP 5</p> <ul style="list-style-type: none"> - Use a thin object to press the Reset Button again. - The learning process of the CG300S2-CCP has now finished.

8. Adding the product to your Home Wireless ZigBee Network

<p>The diagram illustrates the connection process in three steps. Step 1 shows the device's front cover open, revealing a USB socket. Step 2 shows a CG101UTU cable being plugged into the device's USB socket. Step 3 shows the other end of the CG101UTU cable being plugged into the USB port of a laptop.</p>	<p>STEP 1</p> <p>Open the front cover, you will see an USB socket.</p> <p>STEP 2</p> <p>Plug the CG101UTU cable into the USB socket of the product, and then plug the other end of the CG101UTU cable into the mini USB end of the CG101UTC cable.</p> <p>STEP 3</p> <p>Plug the CG101UTC cable into the USB port of a PC that is installed with Citygrow's HomeNET Planner Software.</p> <p>STEP 4</p> <p>Refer to the user manual of "HomeNET Planner" Software to program and set the address of the product.</p>
---	--

9. Clear Memory

Clearing the memory inside of the product will result in:

1. The product will no longer reply to any Panels that it had previously bound to.
2. The product will no longer reply to any Remotes that it had previously bound to.

In order to perform the Clear Memory function, please follow the below steps:

	<p>STEP 1</p> <ul style="list-style-type: none"> - Press and HOLD anyone of the ON/OFF Button.
	<p>STEP 2</p> <ul style="list-style-type: none"> - CONTINUE holding onto the ON/OFF Button. - Press and release the Reset Button once.
	<p>STEP 3</p> <ul style="list-style-type: none"> - Wait until the LED Indicator begins BLINKING. - Release the ON/OFF Button.

	<p>STEP 4</p> <ul style="list-style-type: none">- Press and release the ON/OFF Button again to stop blinking.
	<p>STEP 5</p> <ul style="list-style-type: none">- Press and release the Reset Button.- The memory inside of the CG300 has now been cleared.

10. Specification

	CG300S1	CG300S2	CG300DM	CG300S2-CCP
Description	One Gang Switch	Two Gang Switch	One Gang Dimmer (Leading Edge Dimming)	One Gang Curtain Control Switch
Operating voltage	AC220-240V, 50Hz			
Maximum number of devices included in scene setting , **Remarks 1, 2	50	50	50	NO
**Remarks: 1. When up button is used for dimming up function, the down button cannot be programmed as scene function. 2. Maximum number of devices programmed into the whole product is limited to 50 devices. 3. The maximum load requirements for fluorescent, CFL and LED loads can vary greatly depending upon the specific fixture and /or bulb being used. 4. When dimming transformer is connected to CG300 make sure “dimmable” and “leading edge” type is used. Furthermore, the dimming performance varies greatly from manufacturer to manufacturer of the bulb and the dimming transformer. It is recommended to test the matching performance before mass deployment.				
Minimum dimming level setting	NO	NO	YES	NO
Memory dim function	NO	NO	YES	NO
Two way control function	YES	YES	YES	YES
RF frequency	2.4GHZ	2.4GHZ	2.4GHZ	2.4GHZ
Remote control distance (M, line of sight)	100M	100M	100M	100M
Dimensions mm (Length x Width x Depth)	70x114x44	70x114x44	70x114x44	70x114x44
Recommended operation temperature	0 to 40 degC	0 to 40 degC	0 to 40 degC	0 to 40 degC

	CG300S1	CG300S2	CG300DM	CG300S2-CCP
Description	One Gang Switch	Two Gang Switch	One Gang Dimmer (Leading Edge Dimming)	One Gang Curtain Control Switch
Resistive load 1.Incandescent 2.Halogen 3.Electronic low voltage – ELV transformer	2000W	1000W /gang	600W	
Inductive load 1.Magnetic low voltage – MLV transformer. 2.Iron core / Inductive transformer	2000VA	1000VA /gang	600VA	
Fluorescent	1400W	700W /gang		
Compact fluorescent - CFL	400W Max. 24 pcs CFL**	400W /gang Max. 24 pcs CFL/Gang**	400W Dimmable CFL Max. 20 pcs CFL**	
LED – GU10	200W	200W /gang	60W	
LED – MR16, MR11 With electronic low voltage LED driver	400W Max. 24 pcs ELV LED driver**	400W /gang Max. 24 pcs ELV LED driver /Gang **	120W Max. 15 pcs ELV LED driver**	
LED strip With electronic low voltage driver	400W Max. 10 pcs ELV LED driver**	400W /gang Max. 10 pcs ELV LED driver /Gang **		
Exhaust fan	300VA	300VA /gang		
3 wire type AC curtain motor				300VA
Minimum load			5W	