

1. CG800S1xx, One Gang Switch
2. CG800S2xx, Two Gang Switch
3. CG800S4xx, Four Gang Switch
4. CG800DMxx, One Gang Dimmer
5. CG800DM2xx, Two Gang Dimmer

Wiring Diagram

Notes: The Neutral wire of load is closely connected to the Neutral point of CG800.

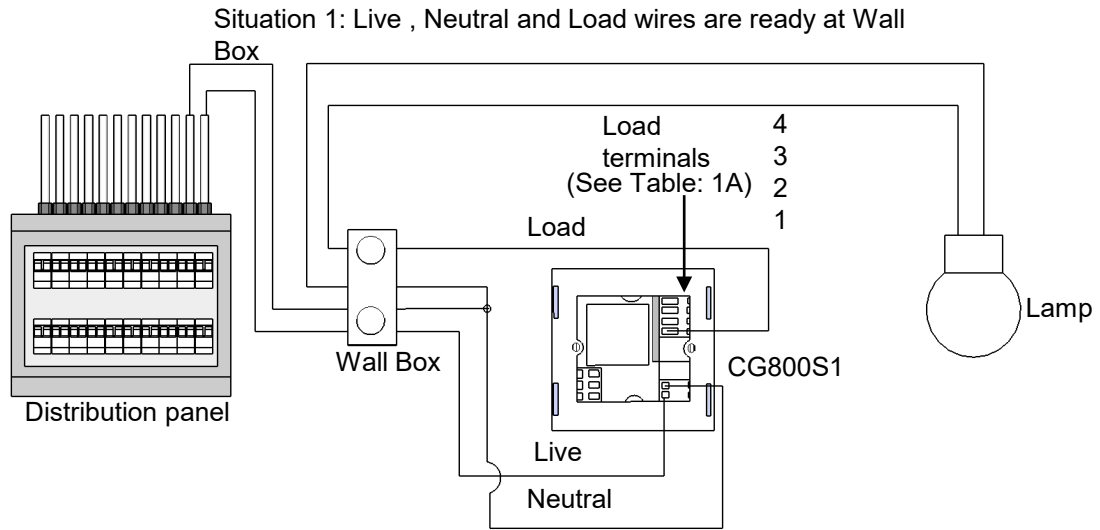

Situation 2: Live and Load wires are ready at Wall Box, Neutral wire is only ready at ceiling

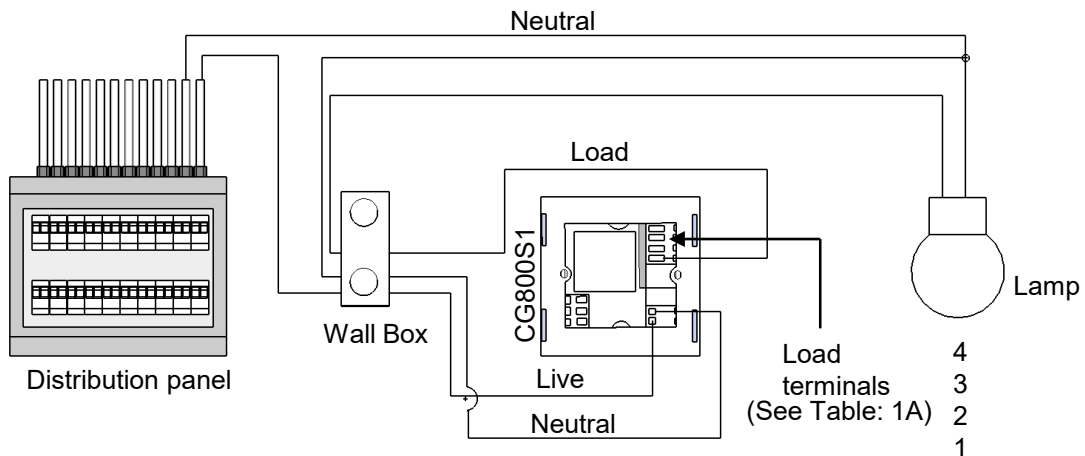

Table 1A

Load terminals	1	2	3	4
CG800S1 One Gang Switch	Load1	NC	NC	NC
CG800S2 Two Gang Switch	Load1	Load2	NC	NC
CG800S4 Four Gang Switch	Load1	Load2	Load 3	Load 4
CG800DM One Gang Dimmer	Load1	NC	NC	NC
CG800DM2 Two Gang Dimmer	Load1	Load2	NC	NC
CG800S2-CCP One Gang Curtain Control Switch	Motor 1 Forward	Motor 1 Backward	NC	NC
CG800S4-CCP Two Gang Curtain Control Switch	Motor 1 Forward	Motor 1 Backward	Motor 2 Forward	Motor 2 Backward